

Planar PPX 110-72 Stainless Steel | 122.0198.208

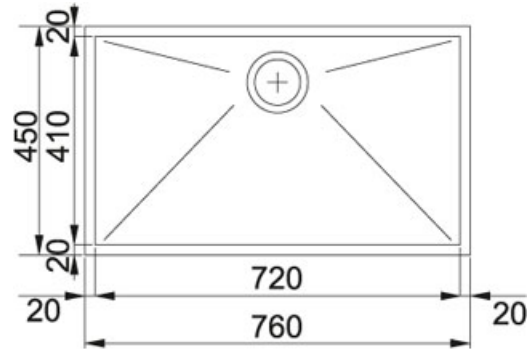





FAMILY : Sinks | SERIE : Planar | MODEL : PPX 110-72 | FINISH : Stainless Steel | INSTALLATION TYPE : Undermount | PRODUCT LINE : Planar



TECHNICAL DATA

Waste Outlet Diameter	3-1/2"
Width overall	450.00 mm
Length of large bowl	720.00 mm
Width of large bowl	410.00 mm
Depth of large bowl	200.00 mm
Number of Bowls	1
Siphon Included	YES
Tap Hole	NO
Cutout Length	720.00 mm
Cutout Width	410.00 mm
Surface Finish	X-BRUSHED/SATIN
Remarks	INTERNAL-BOWL-DIMENSIONS
Cut-Out Template	YES
Status_Production_FIP	ACTIVE
Cabinet Size	900.00 mm
Tap Ledge Worktop	No
Cabinet	90
Cut-Out	TEMPLATE
Dimensions	760X450
Waste Kit Included	YES
Cabinet Position	450
Production plant	FIP
PRODUCT-SHAPE-CHECK	RECTANGULAR WIDTH

FEATURES

	Waste disposal unit optional		Waste with twist remote control optional
	Soap Dispenser optional		Waste kit with pull out remote control optional
	New		Edge profile undermount
	AISI 304		