



SANITARY WARE

USER MANUAL

MESSAGE BATHTUB SERIES

Contents

Profile	Page 1
Installing preparation and attention	Page 1
Step of installation	Page 2
Adjustment.	Page 2
Must be executed	Page 3
Attention	Page 3
Maintenance	Page 3
Using skill	Page 4
Basic circuit of massage bath tub	Page 4
Technical parameters	Page 5
Computer panel use guide	Page 6
Control Panel	Page 7
Remote Controller	Page 7
Manual Operation	Page 8
Failure solution	Page 9

Make your life be classical

Profile

Dear customer:

Thank you for using our massage bathtub. This product series we designed is characterized by its superior material, neat style, comfortable, practical and economical. It is the new generation of leisure product, and it will bring you great relaxation and pleasure bath.

Please check whether the spare parts in order according to the overall chart after opening the packing, and analyze the product structure and installation position of accessory, then start the installation according to the following instruction.

You are welcome to visit our website www.gemy.cn if there is any question.

Installing preparation and attention

1. The installation space should be larger than the product size (see following chart). Please leave proper space in order to install or maintain conveniently.
2. The floor should be level, the wall should be essential vertical, and the wall corner should be 90 degree.
3. The floor should be level and firm (eg. Cement, tile floor) so that the bathtub foot can contact the floor evenly.

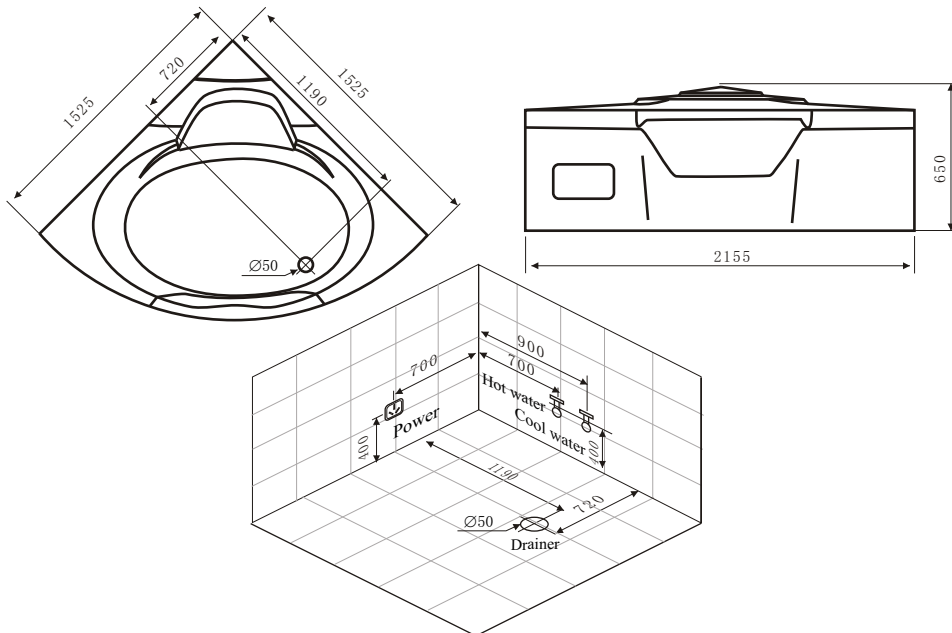

4. The power plug, the cold-hot water pipe connection and the drainage should be got ready in advance according to the electrical instruction picture (see following chart).
5. Check whether all the accessory are in order before installation, and be free to contact us if there is any problem
6. Please prepare the hammer, spanner, screwdriver, multimeter and so on before installation
7. Be careful as far as possible during the installation process, avoiding the sharp and hard object fall straight down to hit or scratch the surface to cause unnecessary loss.

Steps of installation

1. Fitting installation: Open the packing first and take out the bathtub, then install all the fittings.
2. Level test: First, place the massage bathtub at installation point, then check whether it is level by visual test. Second, let proper water in then drain it out, in order to check whether it is at the best state of draining

3. Foot adjustment: Adjust the support foot until it is horizontal.



5. Drainage installation: Install the drainage at the tub bottom first, then connect it to the drain outlet. Please make sure the drain pipe is not flexed.



4. Cold-hot water pipe connection: Move the bathtub slightly toward outside, then install the water pipe with "Cold" or "Hot" mark at the corresponding position.



6. Power connection: Use multimeter to check whether the ground wire in power plug is connect well with the pump surface and support rack, then connect the yellow and green wire with earth. Finally, insert the plug into socket.



7. Installation completion: Push the bathtub to installation position after checking everything is ok, then place the silicon glue along the gap between the wall and bathtub edge. The installation procedure is complete here.

Adjustment.

1. First, turn on the cold water valve after the silicon glue is dry, then adjust the hot water valve until the mixed water with proper temperature. Second, twist the water separating valve to the shower function, then adjust the portable shower, to let the water in and clean the bathtub.

2. When the water level reach a proper position,then start the water pump,adjust the water nozzle,check whether the water pump works well and water leaks or not.

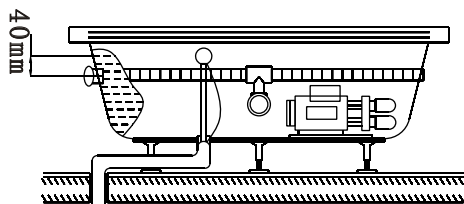

The whole test procedure is complete here.Please read the security attention carefully before using the product,in order to avoid unnecessary damage or loss.Keep the instruction well for subsequent reference after reading.



Warning

1. **This product must be installed by the qualified person.**
2. **The equipotential connection of this product must be jointed In the right way on floor.**
3. **The wire should be connected with the fixed wiring unit.**
4. **The wire should be connected with leakage protector and earth wire unit. (Rated current >20A; Rated leakage protector current ≤30mA) .**
5. **Make sure that the supply voltage is compatible with the rated voltage before using.**
6. **No one should get close to the steam box.**
7. **Never use other shower functions during steaming process.**
8. **The person after drinking, or taking sleeping medicine are not allowed to use this product. Hypertensive patient, patient with heart disease And epileptic are not allowed to use this product.**
9. **Children must be guided to use this product with parent.**

Must be executed

1. It is easy to slip because of the soap water in bathtub,please be careful.
2. Please pay attention to enter bathtub so as not to stumble.
3. Make sure the water reach the proper position when start the water pump.
4. Turn on the cold water valve first when let the water in or use the portable shower,then adjust the hot water valve until the water with appropriate temperature ,so as not to be scalded .
5. Let appropriate water in to clean the bathtub,in order to use conveniently next Time.
6. Please turn off the water valve and draw the plug out, if you will not use the bathtub for long time .









Attention

1. Please don't hit or scratch the bathtub with hard object.
2. Water will leak if the silicon glue desquamate,please make it up once it fall off.
3. Don't use chemical such as acid,alkali,drugs(eg.Hydrochloric acid),solvents etc.,To clean the bathtub.Because the chemical mentioned above is bad for health.

Maintenance

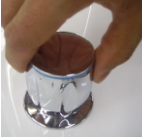
1. Preheat the bathtub with warm water (18-20°C) before using, if the room temperature is too low.Please do not let hot water (more than 50°C) hit bathtub directly。 Drain the water completely after using,then wipe the bathtub up with soft cloth . Make sure there is no waer left in the bathtub, because the left water may freeze
2. If the bathtub is slightly dirty,please use soft cloth or sponge with neutral cleanser to clean. Don't clean the bathtub with nylon product,because it will reduce luster of acrylic.Clean the dirt with flannelette which smeared with toothpaste .The detergent such as acetone,ammonia water and the organic solvent are forbidden to clean the bathtub. Don't sterilize the bathtub with formic acid and druggery includes formic acid, otherwise it will damage the bathtub surface
3. Maintenance of gold-plating accessory: Wipe the gold-plating accessory up lightly with flannelette,should not try with rough cloth
4. Wipe the bathtub with NO2000 sanding paper when it is scratched, then polish it with flannelette and toothpaste

Using skill

1. water output adjustment: Rotate the water nozzle deasil to adjust its water output.		6. Motor start: Press the air switch to let the massage pump on or off.	
2. Direction adjustment of water output: Move the water nozzle toward the directions you like.		7. Massage intensity adjustment: Twist the air switch to adjust the massage intensity.	
3. Sundries cleaning of drainage: Take off the cover to clean away sundries under the drainage.		8. Cold water valve adjustment: Twist the cold water valve to regulate output volume .	
4. Drainage adjustment: Adjust the copper screw of water plug to control the drainage volume.		9. Water separating valve: Twist the valve to switch the function of portable shower and water infall.	
5. Sundries cleaning of water circulation cover: Rotate the cover clockwise to take it off,then screw it on after cleaning.		10. Hot water valve adjustment: Twist the valve to adjust hot water output of portable shower and water infall,also with function of temperature adjustment.	

Using skill

11. Portable shower adjustment. Hold the portable shower pole, then twist the shower head to adjust the volume of water output. There are many kinds of shower function.



Basic circuit of massage bath tub

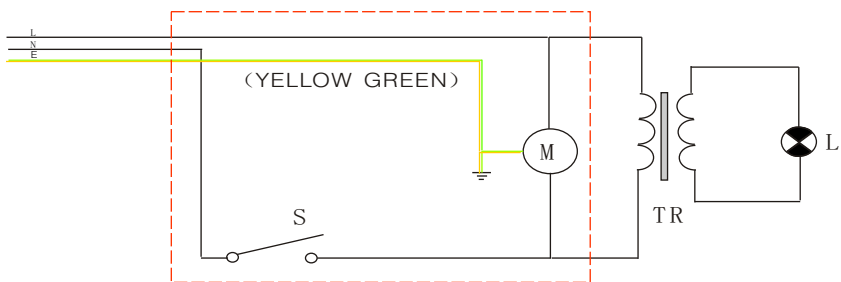

Technical parameters

Working conditions and characteristics				
Rated Voltage	AC220V	Rated frequency	50Hz	
Rated current	6A	Rated Power	1.3KW	
Insulation Resistance	>20M	Waterproof grades	IPX5	
Load configuration parameters				
Load category	Rated load voltage	Rated load frequency	Rated load power	Other
Wind Pump	AC220V	—————	200W	—————
Pump	AC220V	—————	1.1KW	—————
Ozone	AC12V	—————	8W	—————
Waterfall	DC12V	—————	5W	—————
Underwater lights	AC12V	—————	15W	—————

Computer panel use guide

Dear customer, choose the different computer panel according to you the product, your computer control panel possibly is one of these two panels below (the following chart shows). Because its application method is approximately the same, now take BH128JHF for example to introduce operating instructions.

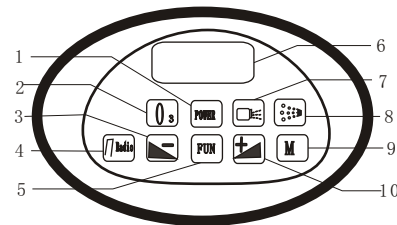

BH238A1 Directions for use

1. Power on/off
2. Ozone on/off
3. Press the key to turn down the frequency /Volume of radio
4. Radio on/off
5. Radio frequency /volume
6. Dynamic latticeliquid crystal display screen
7. Pump on/off
8. Air pump on/off
9. Make selection the channel
10. Press the key to turn up the

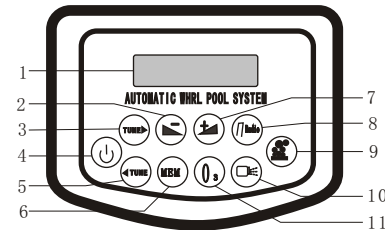

BH308A1 Directions for use

1. Dynamic latticeliquid crystal display screen
2. Press the key to turn down the volume of radio
3. Press the key to turn down the frequency of radio
4. Power on/off
5. Press the key to turn up the frequency of radio
6. Make selection the channel
7. Press the key to turn up the volume of radio
8. Radio on/off

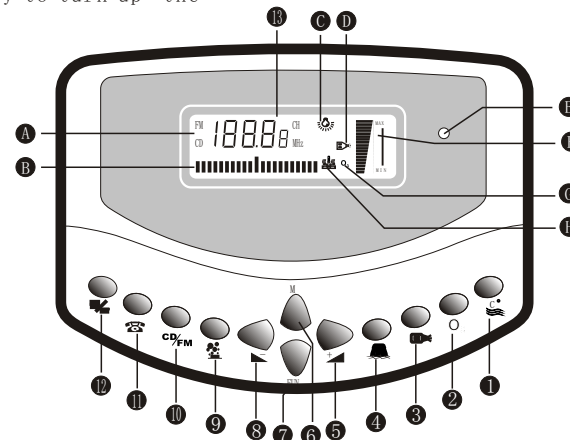

BH128JHF Directions for use

Control Panel

- | | | |
|-----------------------------------|-------------------------------------|---------------------------------|
| ① Water Thermostat On/Off | ⑧ Volume / Function Adjust Down Key | ③ Volume Value Display |
| ② Ozone on/off | ⑨ Air pump on/off | ④ light status |
| ③ Water Pump On/Off | ⑩ FM/CD | ⑤ Water Pump Status |
| ④ Waterfall Control | ⑪ Telephone | ⑥ Remote Control Receive Window |
| ⑤ Volume / Function Adjust Up Key | ⑫ On / Off | ⑦ Air Pump Status |
| ⑥ FM Channel Switch & Store | ⑬ LCD Screen | ⑧ Ozone Status |
| ⑦ Function Switch | ⑭ Function Value Display | ⑨ Water Thermostat Status |

Remote Controller

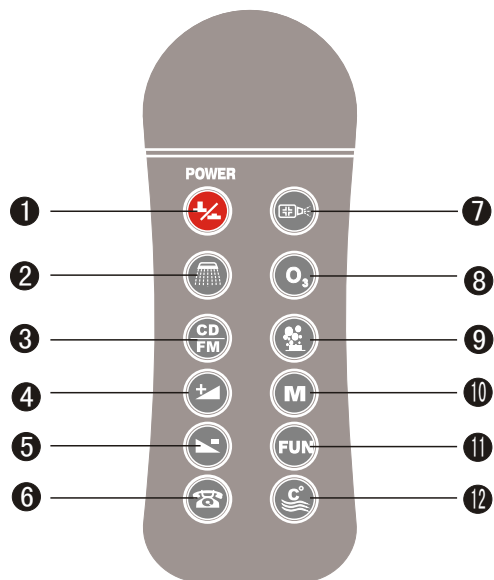

- | | |
|-------------------------------------|-----------------------------|
| ① On/Off | ⑦ Water Pump On/Off |
| ② Waterfall Control | ⑧ Ozone on/off |
| ③ CD/FM | ⑨ Air pump on/off |
| ④ Volume / Function Adjust Up key | ⑩ FM Channel Switch & Store |
| ⑤ Volume / Function Adjust Down Key | ⑪ Function Switch |
| ⑥ Telephone | ⑫ Water Thermostat On/Off |

Manual Operation

1、Turn on/off:

In the state of electricity being on, press Key of the panel or remote panel, the system start, and 1- hour later shutdown function, open all functional operations, the screen shows room temperature with yellow green light. Click here to re-key or time executing shutdown operations to close all open functions.

2、underwater lamp/backlight lamp

In the state of running, Switch on any function of motor and air bubble bath to start the underwater lamp / back light lamp. When surfing and motor function and air bubble bath are both closed, underwater lamp / backlight lamp is closed. When being lack of water, air pumps works for 15 minutes, during this time, underwater lamp / back light lamp can not be turned on.

3、Telephone

Under the of running, when a phone is called in, the phone rings and temporarily close the audio functions. Press button of the panel or remote panel ring to stop, listen to the state by telephone, LCD screen shows TEL words, and temporarily close the pumps, air pumps, and other functions. After the phone call, press this Key to hung up, and automatically restore the original functions.

4、Speaker

Under the state system, presses the panel or remote panel key first to open radio function, the LCD screen shows the current frequency of radio, under radio mode; click FUN Key of the panel or a remote panel, opening FM automatic search broadcasting, click or Key of panel or remote panel to carry out manual broadcasting; press or Key of panel or remote panel for half second, can upward or downward automatically search broadcasting; When received the broadcasting, presses M Key for 2 seconds that could save the current station frequency on the broadcasting, the FM channel switching system into the state when click FUN Key twice, click or key to turn upward or downward for manual switching channels; channel range of 1-8. Click FUN Key Third time, the state entered thermostats regulate temperature. Click this key again, adjust the volume state. Click the panel or a remote panel second time, the system switch CD input states, the LCD screens shows the words of CD, click this Key again to turn off the speaker function.

5、Volume adjustmen

Under CD or Radio states, the state FUN Key not be clicked or in state to adjust the volume, presses panel or remote panel or key to decrease or increase sound volume

6、Motor massage function(water motor)



Under the state system open and water full, press Key of panel or remote panel, which opened pump function, the LCD screen shows icons, and press again to close pump function.(Note: the water pump can not be opened under the system leak water and the LCD screen icon shining.)

7、Thermostat

Under water full and opening of water pumps, press the panel or remote panel Key

Activated thermostat, the LCD screen's temperature icon brightened, and press this Key again to close thermostat. When the bathtub temperature is below the set temperature, the thermostat and heating rods is activated, when the bathtub temperature reached setting temperature, thermostat stop heating rods (if being lack of water, thermostat cannot be started, and it will be shut down automatically if working). Two seconds before the start, when the temperature icon shining, under thermostat press FUN Key of panel or remote panel third time, then press the ▲ or ▼ Key of panel or remote panel can be set thermostat of the water tank. System default temperature is 35 °C. Adjustable range is 15-45 °C.

8、Bubble bath function(air pump)

When the system is open and water is full, press the panel or remote panel  Key once to open air pump. The LCD screen shows air pump icon as follow figure. Press  Key on panel or remote panel by the second time to close the air pump. Under the state of air pump opening, if system changes from full water to lack water, or opening it when lack of water, the air pump will stop after 15 minutes.

9、Disinfection.

Press 03 Key of the panel or remote panel, open disinfection function for 15 minutes, the LCD screen shows icon and remain time, press the Key again to close disinfection.

Failure solution

Problem	Possible reason	Solution
Pump cannot start	The water level has not reached the probe	Continue adding water,let the water level reach the probe
	Air driven switch faulty	Replace
	Loose plug	Fix the plug
	Pump jammed with rubbish	Clear the blockage
Massage failure	Pump is damaged	Replace
	Failure of adjuster	Replace the sealing rubber ring inside
Leakage	Air pipe leakage or loose connection	Clearing the blockage tighten the connection
	Join rings broken	Replace
Shaking is too Severe	Lock nut may be loose	Tighten the nut
	Adhesive glue aging	Use new adhesive glue
Pump runs but the lamp is not working	Ground bolt is loose or free	Adjust ground bolt to touch the ground
	Backwater is jammed	Clear the rubbish in Strainer
Pump runs but the lamp is not working	Lamp circuit is not closed	Fix the lamp circuit
	Bulb is damaged	Replace
	Transformer is damaged	Replace

G9041

Size: 1500*1500*740mm

Function B

Water massage

Option:

- *Bubble massage
- *Computer control panel
- *Radio
- *Ozone sterilization
- *Thermostat



